



# Nothing is as a practical as good theory

Professor Asgeir J. Sørensen

Centre for Autonomous Marine Operations and Systems (NTNU AMOS),  
Department of Marine Technology, NTNU, NO-7491 Trondheim, Norway  
E-mail: [asgeir.sorensen@ntnu.no](mailto:asgeir.sorensen@ntnu.no)

Maths Meets Industry  
22 - 23 September 2016, Trondheim, Norway

# Content

- Marine Cybernetics
- Example 1: From mathematical modelling to innovation and new safety regime at the seas
- Example 2: The formulation and solution of the PDE Helmholtz Equation rules ship and control system design of high speed craft
- Personal view and experience on competence as a differentiator in education, research and business
- NTNU AMOS

# Marine Cybernetics

An aerial illustration of a marine environment. In the top left, three wind turbines stand on a small island. A satellite orbits in the sky. The sea is filled with various vessels: a large oil tanker, a yellow and blue boat, a white research vessel, and a yellow submersible. In the background, there are icebergs and a snowy coastline. In the foreground, a blue boat is near a rocky shore with a small building. A yellow submersible is visible in the water below. The overall scene represents a complex marine system.

**Marine Cybernetics** is the science about techniques and methods for analysis, monitoring and control of marine systems

**Mathematical  
modelling**

**Control  
engineering**

**Information and  
communication  
technology**

The field of **Marine Cybernetics** was created by a couple of students in the middle of 1980's as a consequence of business crises within oil and gas, and later in 1999 developed into a new education program at NTNU

# Research Areas – Asgeir J. Sørensen

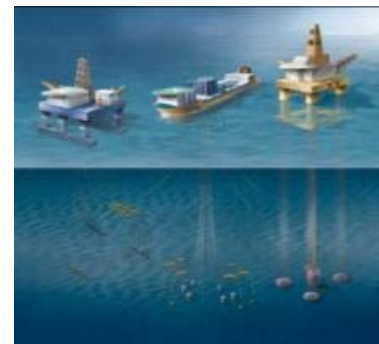
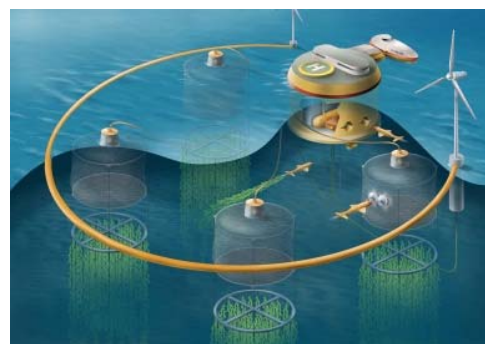
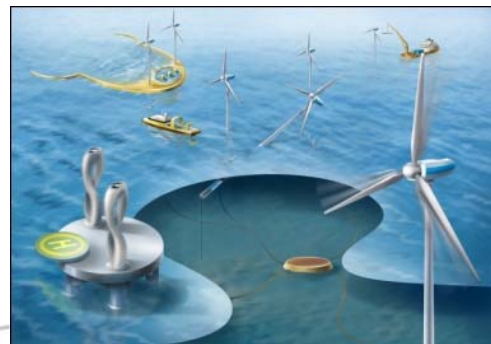
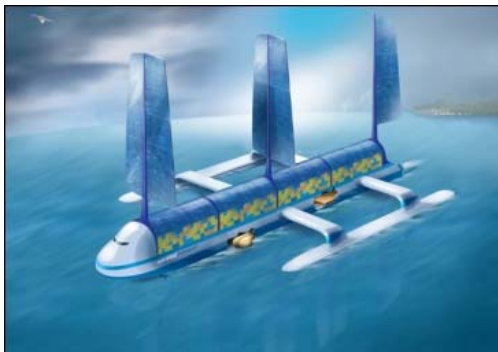

- Underwater robotics
- Dynamic positioning
- Control of flexible marine structures
- Hybrid power plants on ships and rigs
- Offshore wind turbines
- High speed crafts (SES)
- Mathematical modelling
- Hybrid control systems
- Autonomy
- Numerical simulations

# Mathematics the language into marine cybernetics

- Calculus and linear algebra in mathematical modelling and control system design, synthesis and analysis
- Linear and nonlinear ordinary differential equations (ODE) and partial differential equations (PDE)
- Functional analysis in stability analysis regarding control system design
- Numerical methods in simulations
- Fourier analysis in signal processing
- Discrete mathematics and Boolean algebra in software implementation of control systems
- ...

## Take home message:

Thrust the fundamentals in mathematics and physics, and never be outdated and ruled out ....

# Research Methodology

- The research areas addressed are complex and multi-disciplinary
- The research methodology will have a solid foundation on
  - theoretical,
  - Numerical,
  - model-scale and
  - full-scale/field experimental studies

# Theory – Simulation – Experiments – Operations

Bridging the gap from theory to practice

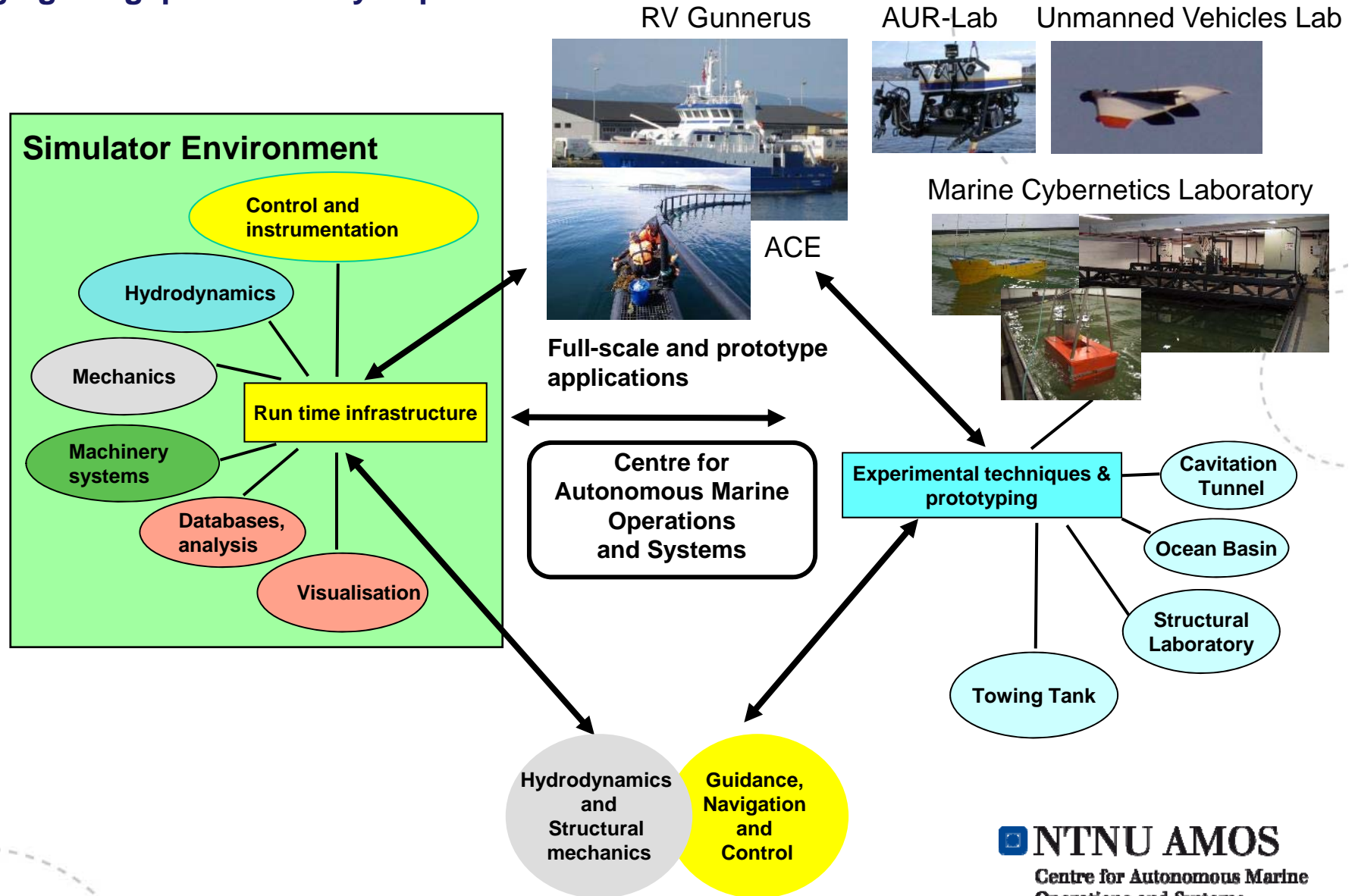

# Content

- Marine Cybernetics
- Example 1: From mathematical modelling to innovation and new safety regime at the seas
- Example 2: The formulation and solution of the PDE Helmholtz Equation rules ship and control system design of high speed craft
- Personal view and experience on competence as a differentiator in education, research and business
- NTNU AMOS



# Example1: Mathematical modelling

- Development of complex multi-physical dynamical models to be solved by sophisticated numerical methods such as CFD, FEM, integration methods, ..
- The art of model reduction of multi-physical systems creating analytical models used in verification of numerical models and model-based controllers

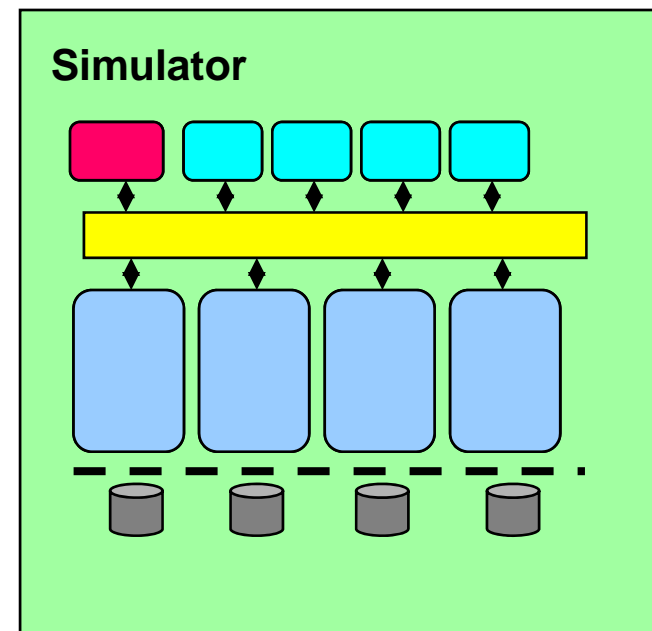
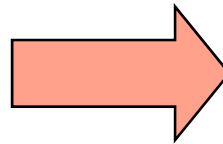

# Off-line Simulation

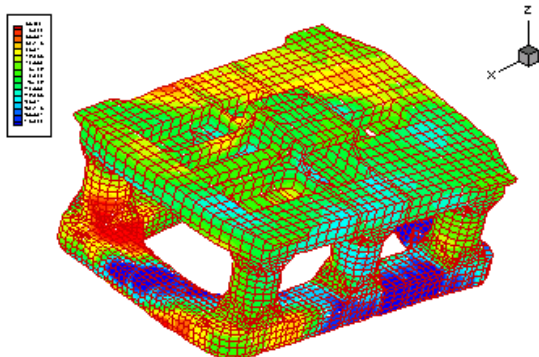

## Purpose:

- Solving dynamic equations of motion (ODE, PDE)
- Static analysis
- Calculation of coefficients (i.e. current, wind, RAOs)

## Characteristics:

- “Office” simulation with no strict requirements to computer execution time (apart from ASAP)
- Often advanced (high-fidelity) models
- Advanced numerical methods, e.g. CFD, FEM
- Used in research, design, engineering, decision support, etc. of ships and equipment
- As computer capacity increases more advanced models and operations may be simulated
- Both isolated phenomena and complex systems are studied with corresponding tailored-made SW tools

# Real-time Simulation

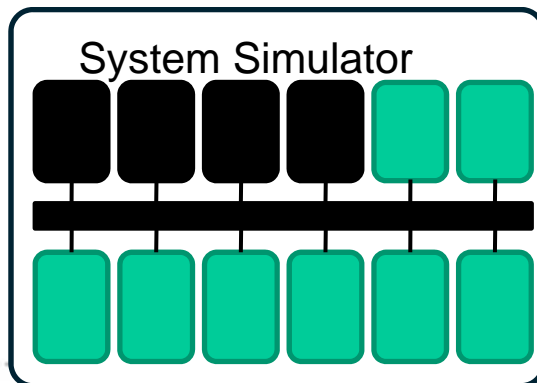

## Purpose:

- Solving dynamic equations of motion (ODE, PDE)
- System simulation of multi-physical models (mechanical, electrical, chemical/combustion)
- Hardware-In-the-Loop (HIL) simulation

## Characteristics:

- Strict requirements to real-time performance ensuring execution within given sampling interval
- Low-fidelity models
- Used in research design, training and testing of control systems
- May also be connected to real control systems
- As computer capacity increases more advanced models and operations may be simulated



# Hardware-In-the Loop (HIL) Testing

Functional and black-box testing using simulator technology



- HIL testing is accomplished by connecting a simulation PC in the system's communication network.
- Inputs to the equipment under test are simulated.
- The controllers respond as they would in a dynamic environment.
- Simulator responds to output from the controllers as the dynamic system would.
- Software (core SW and/or configuration) errors are exposed.

Courtesy to Marine Cybernetics

# Hardware-In-the Loop (HIL) Testing

Functional and black-box testing using simulator technology

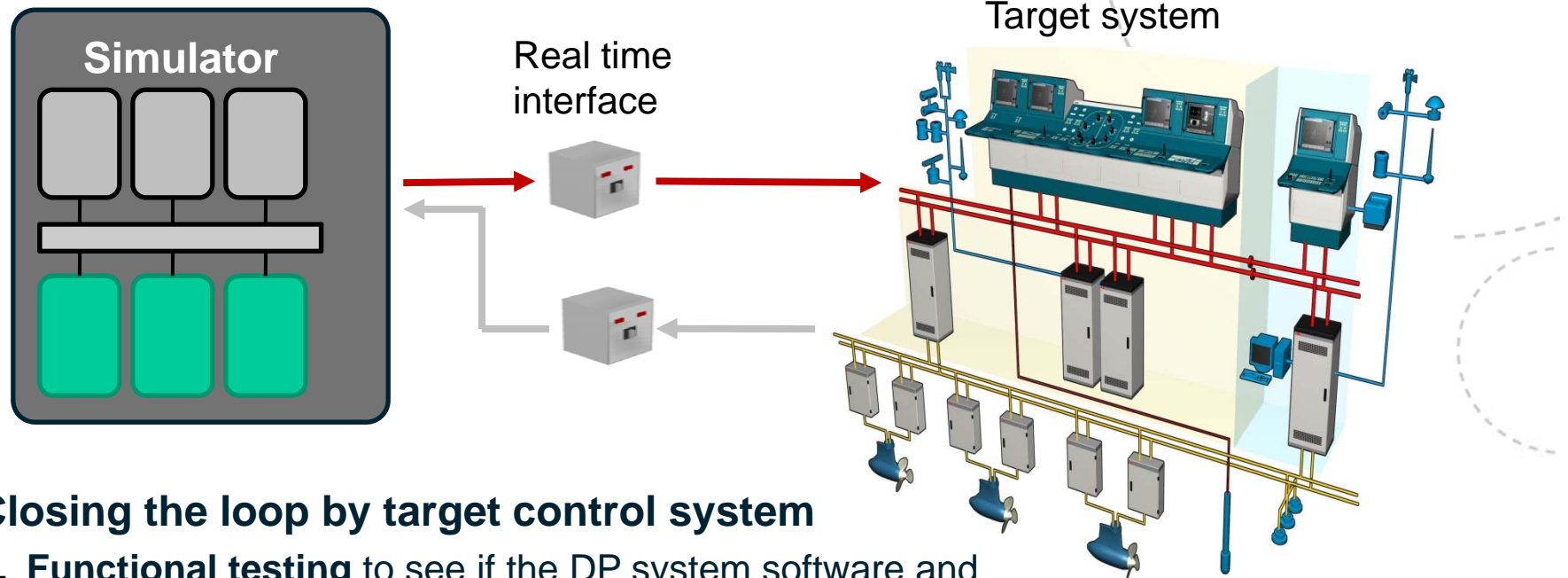

## Closing the loop by target control system

1. **Functional testing** to see if the DP system software and hardware work as specified
2. **Failure testing** to check if the DP system software and hardware is sufficiently resilient to relevant failure situations
3. **Performance testing** is to some extent possible to verify the DP vessel performance

# A FOUNDER STORY: MARINE CYBERNETICS

From 0 to NOK 100 millions in annual revenue in 10 years  
About 75 employees in Trondheim, Oslo, Stavanger, Rio de Janeiro,  
Houston

Startup 2002, Acquired by DNV GL May 2014

# Content

- Marine Cybernetics
- Example 1: From mathematical modelling to innovation and new safety regime at the seas
- **Example 2: The formulation and solution of the PDE Helmholtz Equation rules ship and control system design of high speed craft**
- **Personal view and experience on competence as a differentiator in education, research and business**
- **NTNU AMOS**



# **Example 2: Modelling and Control of Flexible Systems**

-

## **Ride Control of Surface Effect Ships**

**Asgeir J. Sørensen, PhD Thesis, 1993**

# Surface Effect Ships - SES



Length overall	35 m
Equilibrium fan flow rate	150 m <sup>3</sup> /s
Linear fan slope	-140 m <sup>2</sup> /s
Cushion length	28 m
Nom. cushion pressure	500 mm Wc
Cushion beam	8 m
Cushion height	2 m
Weight	150 ton
Speed	50 knots

Use of analytical PDE in modelling and analysis of acoustics and cobblestone effect and nonlinear passivity control system design affecting both controller and SES design of valves, sensor and fans locations



# Boundary Value Problem - Helmholtz Equation

In time domain the Wave equation appears from the Helmholtz equation (frequency domain) according to:

$$\frac{\partial^2 \phi_{sp}(x,z,t)}{\partial t^2} - c^2 \left( \frac{\partial^2 \phi_{sp}(x,z,t)}{\partial x^2} + \frac{\partial^2 \phi_{sp}(x,z,t)}{\partial z^2} \right) = 0$$

$\phi_{sp}(x,z,t)$  is velocity potential of the spatially varying pressure

$c$  is the speed of sound in air

One dimensional approximation of velocity potential:

$$\psi_{sp}(x,t) = \frac{1}{h_0} \int_0^{h_0} \phi_{sp}(x,z,t) dz$$

Integrating the wave equation in z-direction:

$$\frac{c^2}{h_0 b} \int_{-b/2}^{b/2} dy \left( \frac{\partial \phi_{sp}(x,z,t)}{\partial z} \Big|_{z=h_0} - \frac{\partial \phi_{sp}(x,z,t)}{\partial z} \Big|_{z=0} \right) + c^2 \frac{\partial^2 \psi_{sp}(x,t)}{\partial x^2} - \frac{\partial^2 \psi_{sp}(x,t)}{\partial t^2} = 0$$

Non-dimensional spatially varying pressure is:

$$\mu_{sp}(x,t) = -\frac{\rho c_0}{p_0} \frac{\partial \psi_{sp}(x,t)}{\partial t}$$

# Boundary Value Problem - Helmholtz Equation

A modal representation of non-dimensional spatially varying pressure:

$$\mu_{sp}(x, t) = -\frac{\rho c^0}{p_0} \sum_{j=1}^{\infty} \frac{\partial \psi_{sp}^t(t)}{\partial t} \psi_{sp}^x(x) = \sum_{j=1}^{\infty} \dot{p}_j(t) r_j(x)$$

$\dot{p}_j(t)$  is the modal amplitude function for mode  $j$   
 $\psi_j^x(x) = r_j(x)$  is the mode shape function or eigenfunction for mode  $j$

Eigenvalue equation:

$$-c^2 \frac{\partial^2}{\partial x^2} (r_j(x)) = \omega_j^2 r_j(x), \quad j = 1, 2, 3, \dots, k,$$

$\omega_j$  is the eigenfrequency for mode  $j$

# Equations of Motion and Dynamic Cushion Pressure

## 2. Spatially varying pressure

$$\mu_{sp}(x, t) = \sum_{j=1}^{\infty} \dot{p}_j(t) \cos \frac{j\pi}{L} \left( x + \frac{L}{2} \right), \quad x \in \left[ -\frac{L}{2}, \frac{L}{2} \right]$$

The odd modes about the centre of pressure for  $j = 1, 3, 5, \dots$ :

$$\ddot{p}_j(t) + 2\xi_j \omega_j \dot{p}_j(t) + \omega_j^2 p_j(t) = -c_{2j} \dot{\eta}_5(t) + c_1 \sum_{i=1}^r \cos \frac{j\pi}{L} \left( x_{Li} + \frac{L}{2} \right) \Delta A_i^{RCS}(x_{si}, t) + \rho_{c0} \dot{V}_j(t)$$

$$c_1 = \frac{2K_2 c^2}{p_0 V_{c0}} \quad c_{2j} = \frac{4\rho_{c0} L c^2}{p_0 h_0 (j\pi)^2} \quad \dot{V}_j(t) = -\frac{4c^2}{p_0 h_0 L} \frac{k \cos \frac{kL}{2}}{k^2 - \left(\frac{j\pi}{L}\right)^2} \omega_e \zeta_a \sin \omega_e t$$

The even modes about the centre of pressure for  $j = 2, 4, 6, \dots$ :

$$\ddot{p}_j(t) + 2\xi_j \omega_j \dot{p}_j(t) + \omega_j^2 p_j(t) = c_1 \sum_{i=1}^r \cos \frac{j\pi}{L} \left( x_{Li} + \frac{L}{2} \right) \Delta A_i^{RCS}(x_{si}, t) + \rho_{c0} \dot{V}_j(t)$$

$$\dot{V}_j(t) = \frac{4c^2}{p_0 h_0 L} \frac{k \sin \frac{kL}{2}}{k^2 - \left(\frac{j\pi}{L}\right)^2} \omega_e \zeta_a \cos \omega_e t$$

The relative damping coefficient for  $j = 1, 2, 3, \dots$ :

$$\zeta_j = \frac{c}{j\pi h_0 b} \left( \frac{K_2}{2p_0} A_0 + \frac{K_2}{2p_0} \sum_{i=1}^r A_{0i}^{RCS} \cos^2 \frac{j\pi}{L} \left( x_{Li} + \frac{L}{2} \right) - \rho_{c0} \sum_{i=1}^q \frac{\partial Q}{\partial p} \Big|_{0i} \cos^2 \frac{j\pi}{L} \left( x_{Fi} + \frac{L}{2} \right) \right)$$

# Observation and control spillover

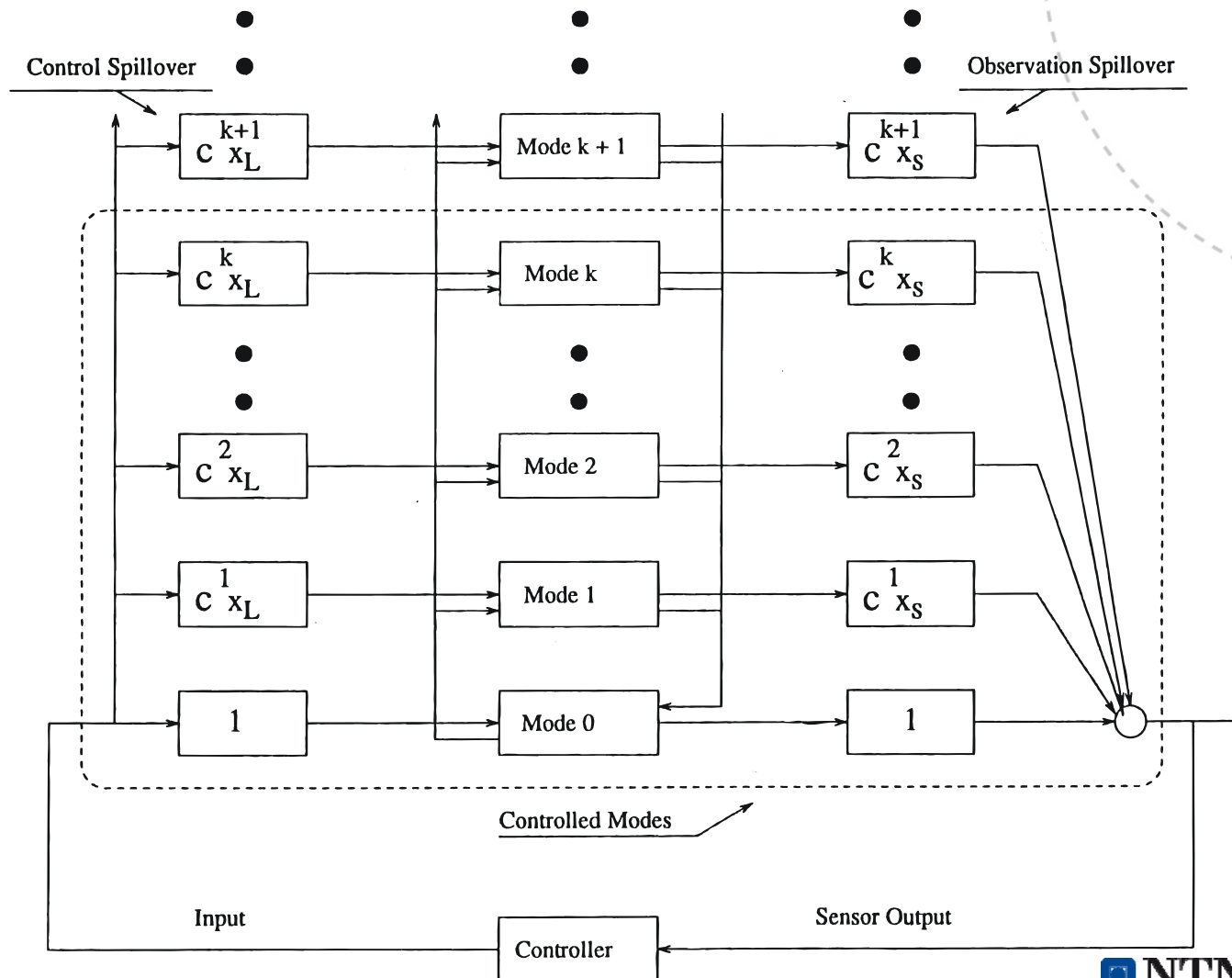

# Passivity-based control system design

Assume perfect collocation of sensors and louvers, then it is possible to establish:

$$\mathbf{C} = \mathbf{B}^T \mathbf{P} \quad x_{Li} = x_{si}$$

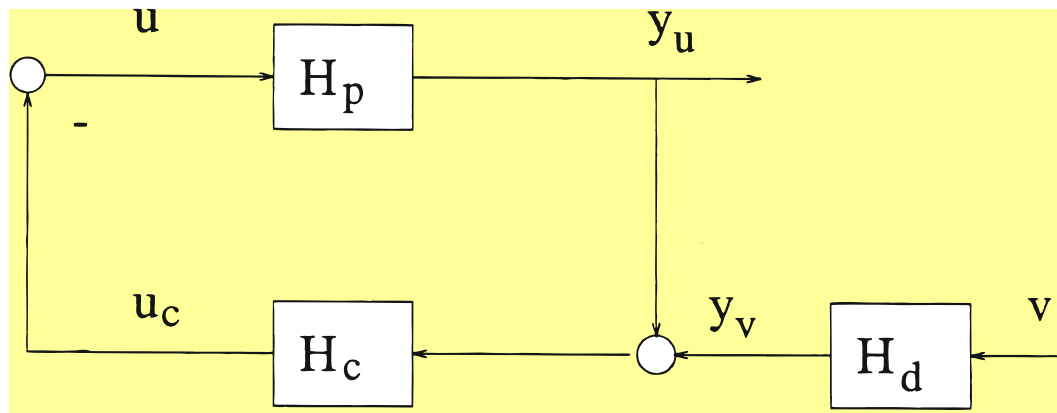

Linear time-invariant operators:

$H_p$  - process

$H_d$  - disturbance

$H_c$  - controller

$$\begin{aligned} \mathbf{y}(s) &= H_p(s)\mathbf{u}(s) + H_d(s)\mathbf{v}(s) \\ &= \mathbf{y}_u(s) + \mathbf{y}_v(s) \end{aligned}$$

$$H_p(s) = \mathbf{C}(s\mathbf{I}_n - \mathbf{A})^{-1} \mathbf{B}$$

$$H_d(s) = \mathbf{C}(s\mathbf{I}_n - \mathbf{A})^{-1} \mathbf{E}$$



# Bode plot - Noncollocated system

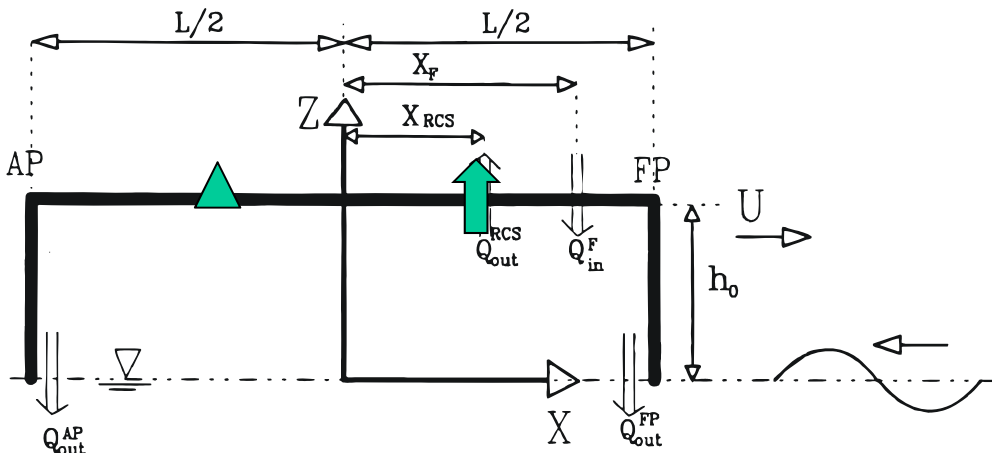

▲ Sensor  
 ↑ Actuator

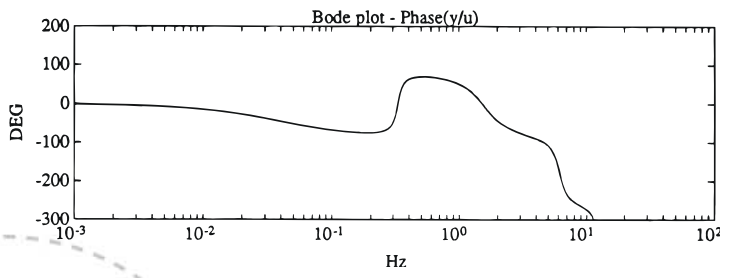
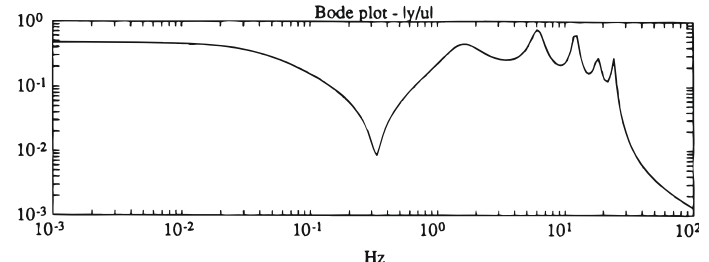

# Power Spectrum - Noncollocated system

## Vertical Acceleration at $x = -5\text{m}$ on 35m SES

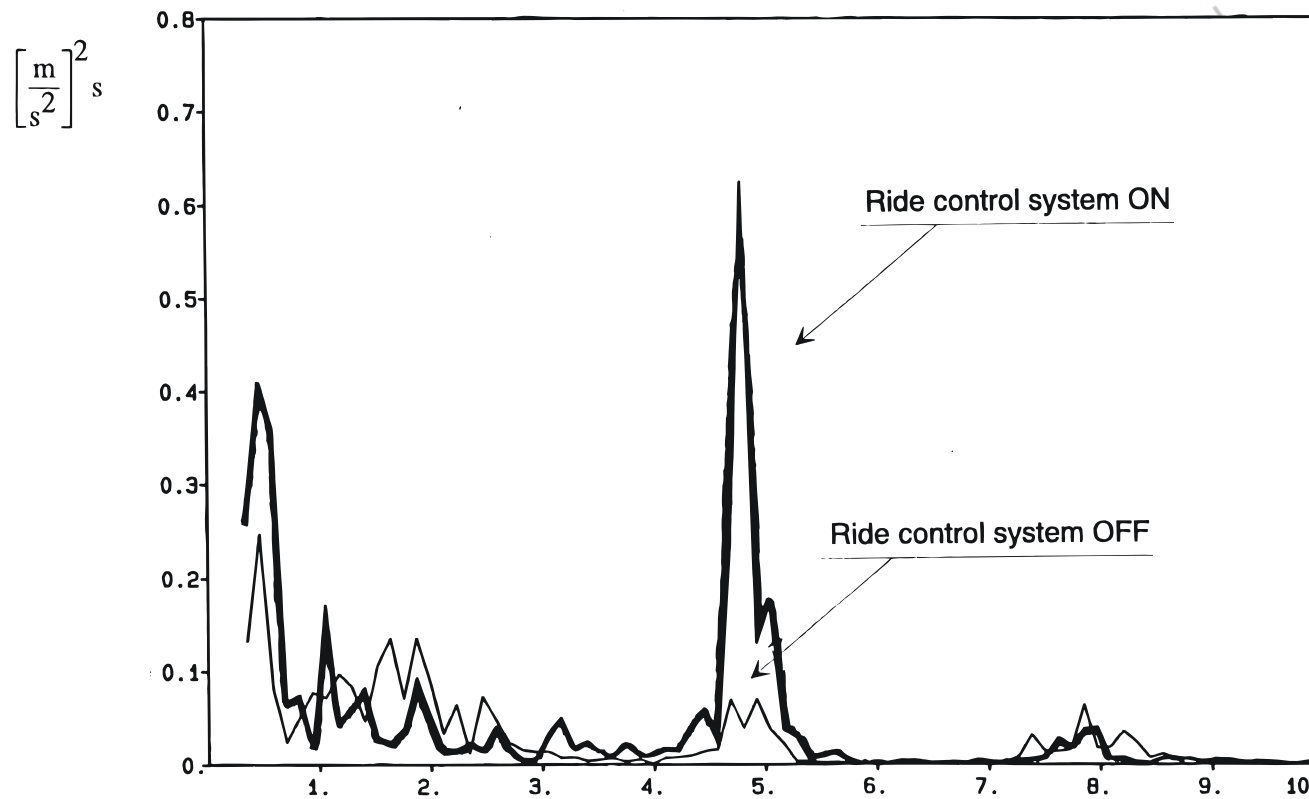

[Hz]



# Power Spectrum - Collocated system

## Vertical Acceleration at x = - 5m on 35m SES

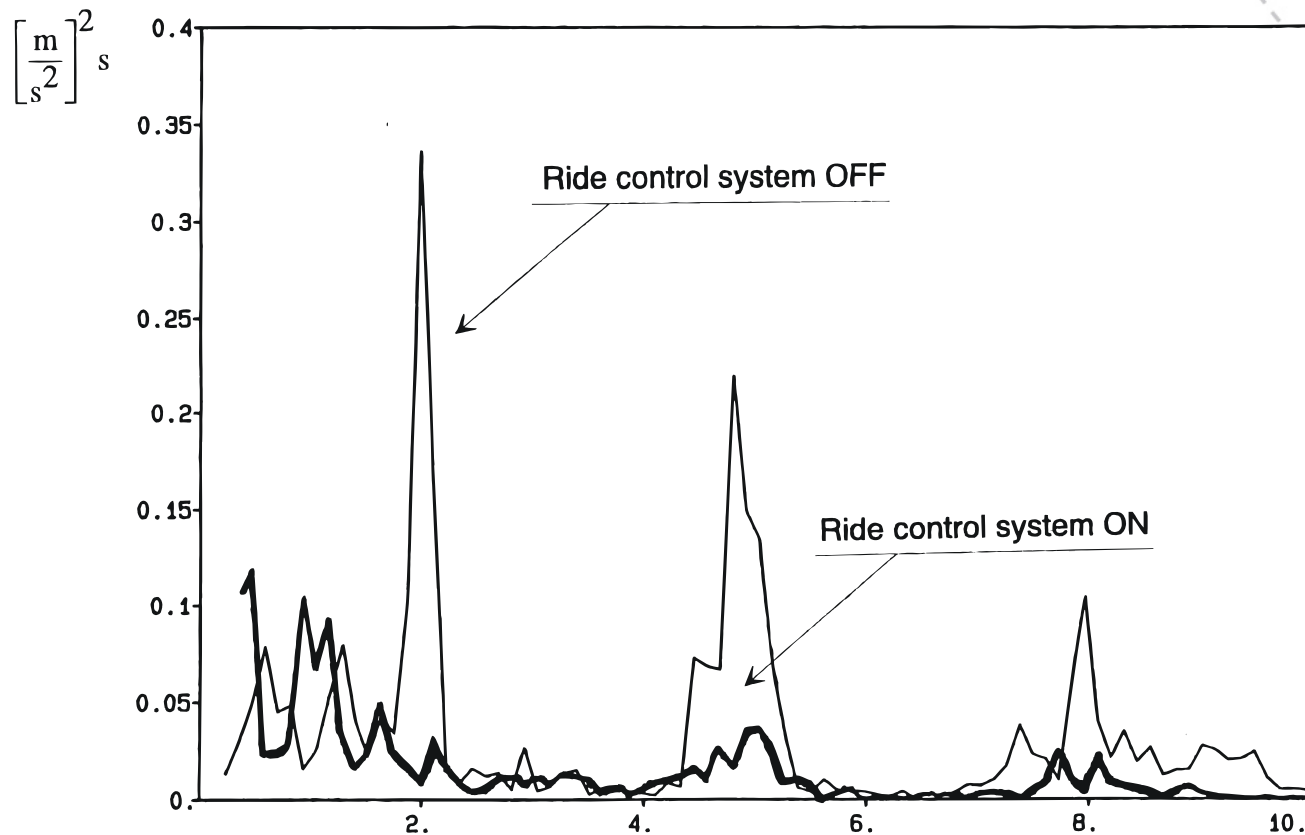

# Content

- Marine Cybernetics
- Example 1: From mathematical modelling to innovation and new safety regime at the seas
- Example 2: The formulation and solution of the PDE Helmholtz Equation rules ship and control system design of high speed craft
- **Personal view and experience on competence as a differentiator in education, research and business**
- **NTNU AMOS**

# Why becoming a professor and founder ...

- Create knowledge and technology for a better world
- Educate the next generation of engineers and scientists
- Develop technology and services that are unique and profitable (new, valuable and taken in use)
- Be inspired by new discoveries and inventions
- Be surrounded by enthusiastic and dedicated people
- Have fun
- Make a difference – have impact

# Long term performance drivers

## – a matter of an entire life

- Define step-wise goals including required qualifications and skills reaching them
- Develop strategic and tactical skills
- Build up capacity by training, education and execution
- Managing quality
- Create the future by driving changes
- **Balancing energy** - this is a long term 40-50 years marathon
- Ability to handle successes, failures and recoveries
- Adapt to best practice and **wisdom** wherever you find it

# Balancing energy and dilemmas

- Knowledge of yourself:
  - Strength, weakness,...
  - Even your own medals do have a back side
- Trust, acceptance, objections
  - friends, family, colleges, managers
- Extreme performance means that you probably will face your limitations and border lines sooner

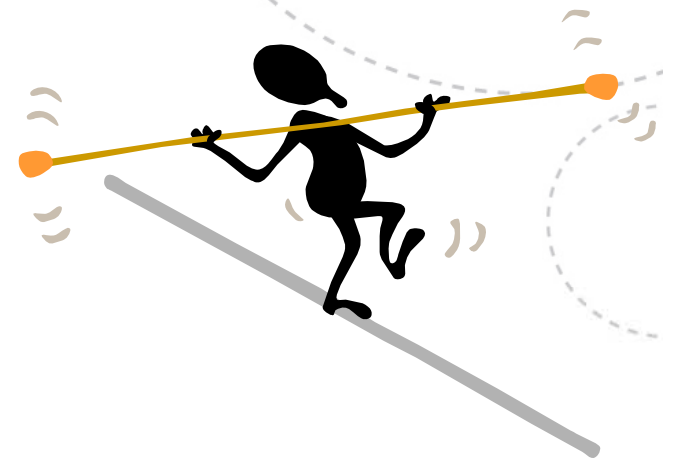

## Taking consequence:

Being world-class shaped over years means a structured life similar to top sport athletes



# Success factors

- Comparative advantages
- Unique selling proposition
- Change the rules of the game
- Speed in implementation
- Endurance
- Team work
- Generosity pays off in the long term



**An multidisciplinary approach creates more values and is harder to copy - “Monopoly position”**

# Innovation and creative power

- Knowledge
- Ambition
- Moment of inspiration
- Vision
- Turning vision into reality
- Plan the work
- Work the plan

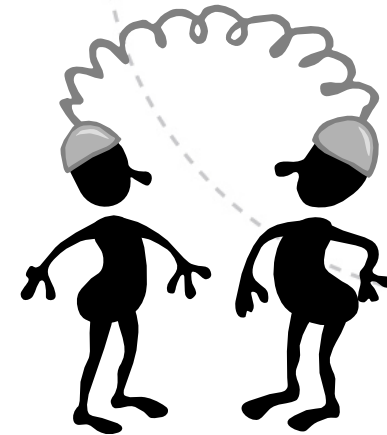

**Big innovations and discoveries are characterized by 1% inspiration and 99% hard work**

# The topmost 10 things to...

1. **Hard work** to continuously improve your performance
2. **Innovative** stimulate your thought and creativity, and trust your intuition
3. **Courage** – be ambitious and go for it, even if you risk to fail...
4. **Plan**, define performance goals and manage your career step by step
5. **Networking**: Be aware of the importance of networks and alliances
6. **Organization**: Establish research groups and research projects
7. **Communication**: Do not underestimate the efforts in sales, politics to achieve impact
8. **Rules of the game**: Learn the decisions mechanisms, and maneuvering yourself into position
9. **Integrity**: Do never compromise your ethics and integrity
10. **Care**: Be kind with yourself

# Content

- Marine Cybernetics
- Example 1: From mathematical modelling to innovation and new safety regime at the seas
- Example 2: The formulation and solution of the PDE Helmholtz Equation rules ship and control system design of high speed craft
- Personal view and experience on competence as a differentiator in education, research and business
- **NTNU AMOS**

# Norway manages oceans that are 5 times larger than terrestrial areas

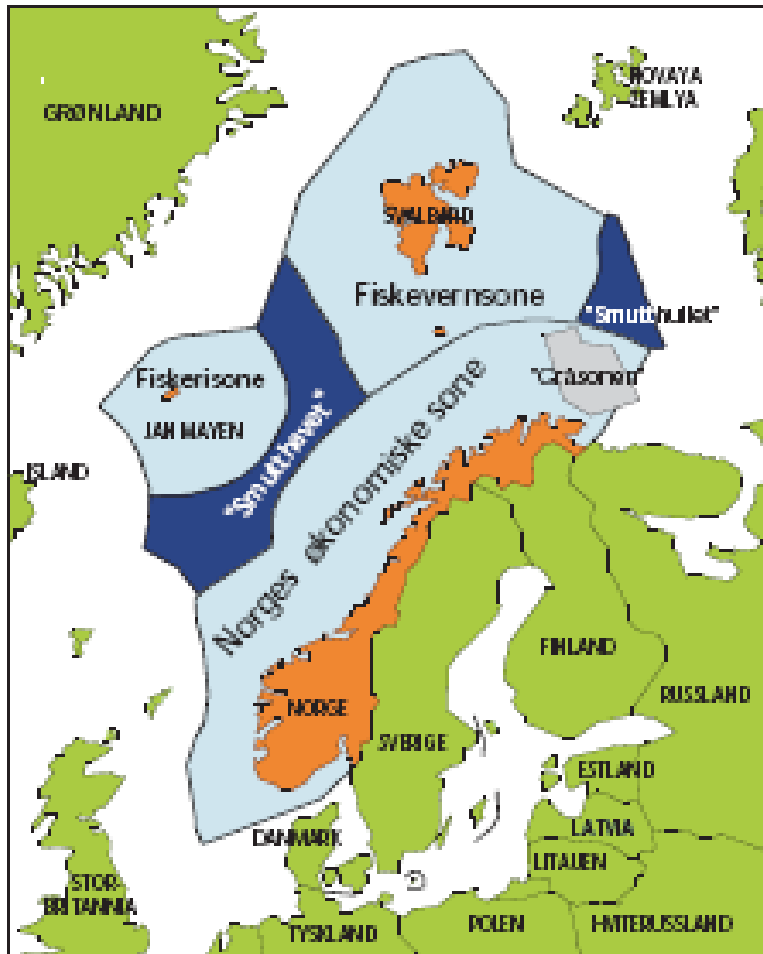

Huge potential for harvesting food, energy, minerals and marine resources

Norway has a global responsibility for sustainability and knowledge-based management of the oceans and the Arctic

# Ocean Space - The blue economy

Shipping

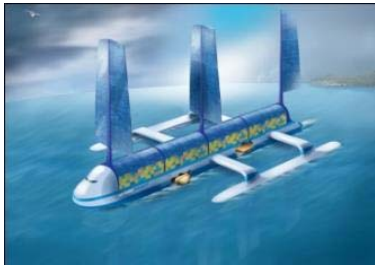

Ocean Science and Management



Marine mining



Tourism and consumer market

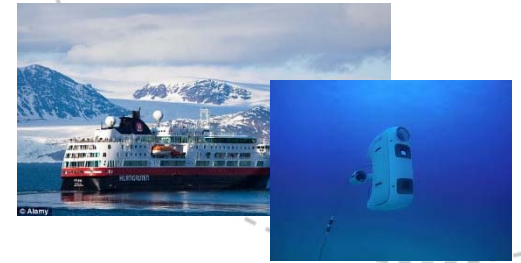

Offshore renewable energy



**SUPER CLUSTER**

Fisheries

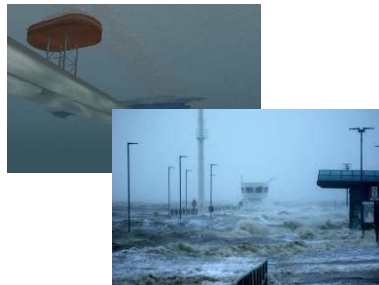

Coastal infrastructure

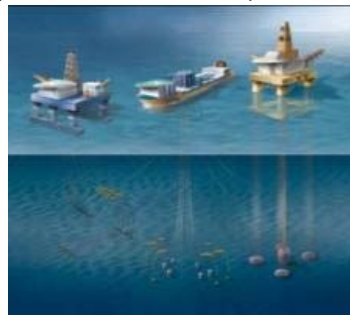

Oil & gas in deeper water...



.... and in Arctic areas

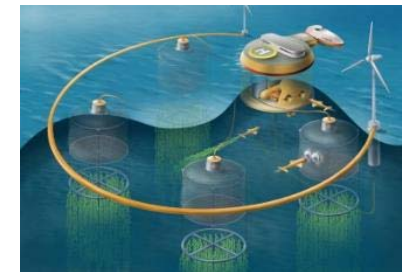

Aquaculture and biological production

# Global Challenges and Opportunities

The humanity is facing increasing global challenges such as global warming, increased population and lack of energy, food and minerals



Such challenges are also a possibility for you to make a significant difference

# Sustainability by a holistic approach

“If you can measure you can manage”:  
Politics, regulations, social acceptance,  
ethics, accept criteria, standards, certification

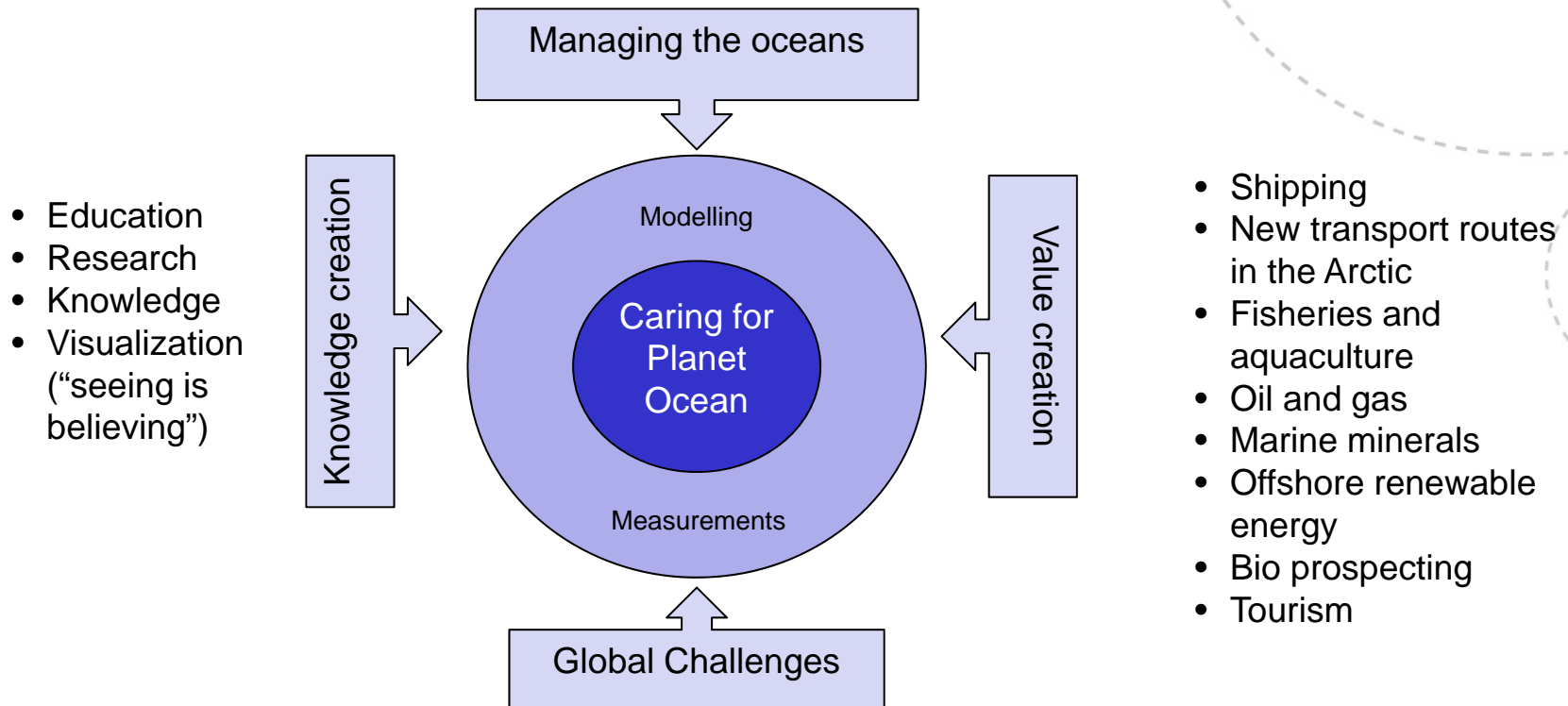

The humanity is facing increasing global challenges such as global warming, deteriorating ecosystems, population explosion and lack of energy, food, water and minerals



# Vision

- Establish a **world-leading research** centre on autonomous marine operations and systems
- Create **fundamental knowledge** through multidisciplinary research
- Provide **cutting-edge interdisciplinary research** to make autonomy a reality for ships and ocean structures, unmanned vehicles and marine operations

**NTNU AMOS will contribute to improved international competitiveness of Norwegian industries as well as to safety and protection of the marine environment**



# Next step in research, education and innovation

Knowledge fields & research methods

Hydrodynamics and Structural Mechanics

Guidance, Navigation and Control

Numerics  
Theory  
Experiments

New: Big Data Cybernetics, Sensor Fusion, Computer Vision, Artificial Intelligence, Marine Biology, Archeology, Geology, Oceanography

*NTNU AMOS*

NTNU Centre for Autonomous Marine Operations and Systems

Interdisciplinary research areas & challenges



Greener operations



Offshore renewable energy

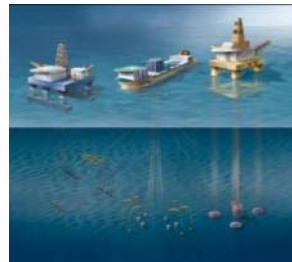

Oil & gas in deeper .... and in Arctic areas



Autonomous surveillance

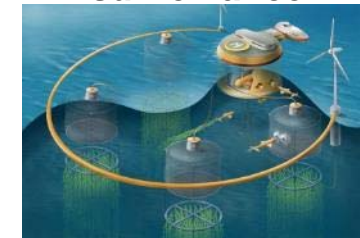

Open water biological production

# NTNU AMOS Facts and Figures (Phase 1: 2013-2017)

## Personnel by end of 2015:

- 6 Key scientists/professors
- 2 Scientific advisors/professors
- 10 Adjunct professors
- 13 Affiliated professors
- 4 Post Docs/researchers
- 5 visiting profs./researchers
- 81 PhD candidates
- 2 administrative staff
- 2 + lab engineers
- 3 Spin off companies

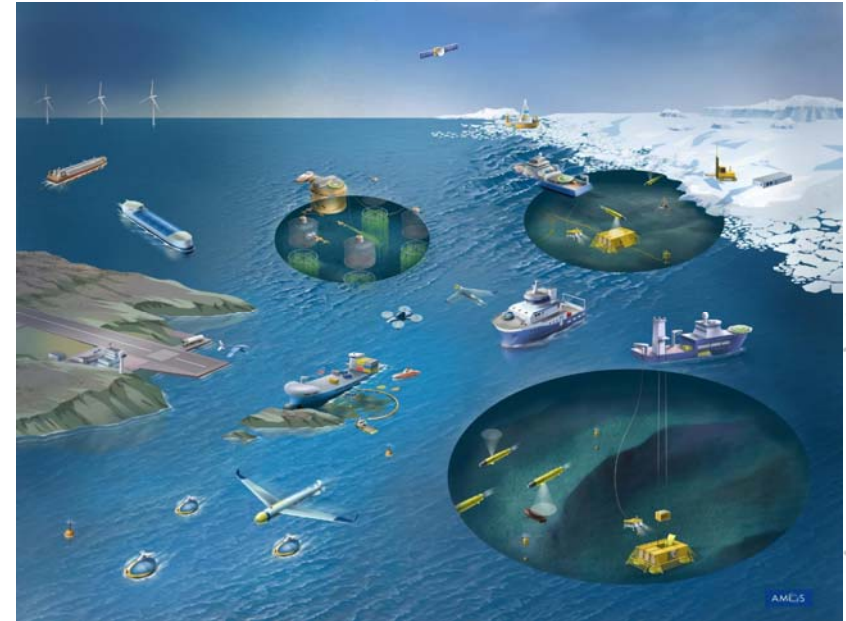

## Partners and collaborators:

### Partners:



MARINTEK



SINTEF

**International collaborators:** Denmark, Sweden, Portugal, Italy, Croatia, USA, Australia, Ukraine

**National collaborators:** University of Tromsø, UNIS, UNIK, Kongsberg Maritime, Rolls-Royce Marine, FMC, Ecotone, Maritime Robotics, FFI, NGU, Ulstein Group, Eelume, NORUT, Marine Technologies, Akvaplan Niva, ...

**Budget (10 years):** 800+ MNOK (~95 MEUR)



**NTNU AMOS**  
Centre for Autonomous Marine  
Operations and Systems

# **New business by enabling technologies and fundamental knowledge fields**

- **Mathematics, physics, chemistry, biology, engineering cybernetics, marine technology**
- **Information and communication technology**
- **Nano technology**
- **Bio technology**
- **Material technology**
- **Big data cybernetics and data analytics**
- **Integration of disciplines and technologies**
- **Multi-scale and distributed systems for sensing and actuation: Micro to macro (M2M)**
- **.....**

**Research and innovations based on disruptive game changing technology beyond imagination.....**



# Autonomous unmanned vehicles and operations – 4 projects

- Autonomous unmanned vehicle systems
- Autonomous underwater robotics for mapping, monitoring and intervention
- Autonomous aerial systems for marine and arctic monitoring and data collection
- Safety, risk and autonomy in subsea operations

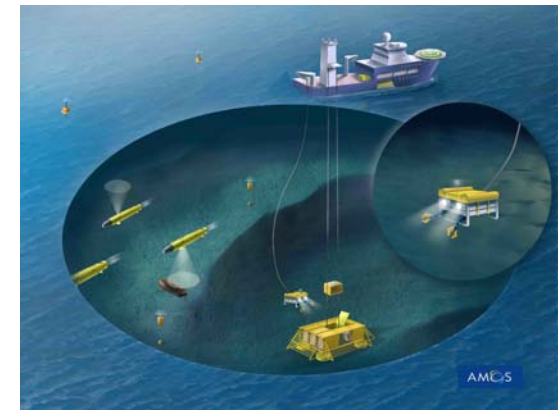
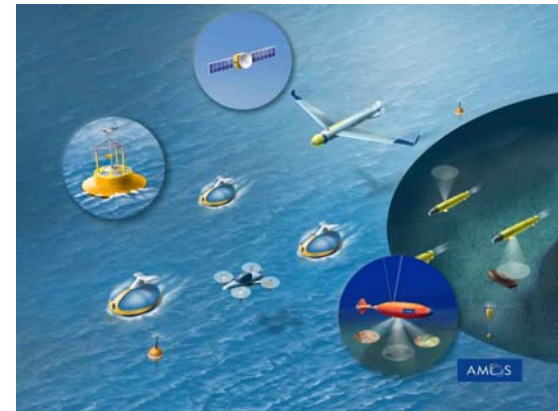

# Smarter, safer and greener marine operations and systems – 5 projects

- Optimization and fault-tolerant control of offshore renewable energy systems
- Intelligent offshore aquaculture structures
- Energy management and propulsion for greener operations of ships and offshore structures
- Autonomous marine operations in extreme seas, violent water-structure interactions, deep waters and Arctic
- Consequences of accidental and abnormal events on ships and offshore structures

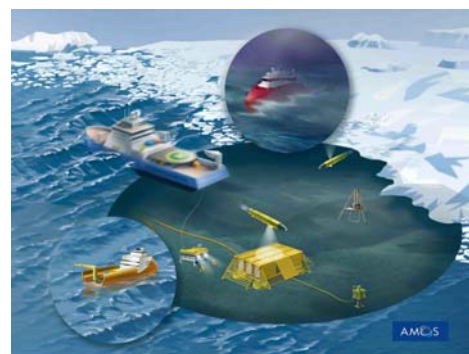
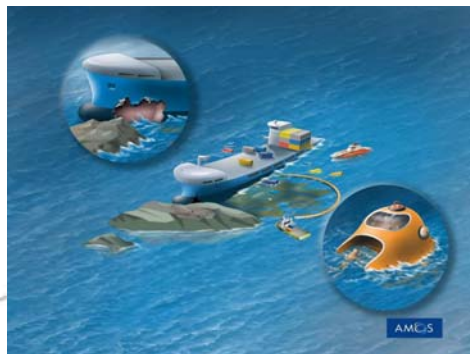
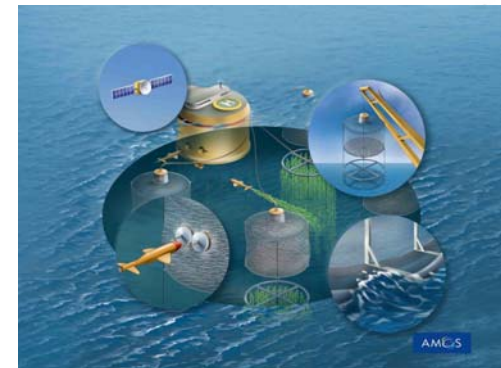

**NTNU AMOS**  
Centre for Autonomous Marine  
Operations and Systems